



INSTALLATION INSTRUCTIONS ENGINE SPIN-ON ADAPTER KIT PART # 35703, 35704, 35706 & 35724

Please read these instructions completely before beginning installation

KIT CONTENTS	
QTY.	DESCRIPTION
1	Spin-On Adapter
1	O-ring
1	Hex Sleeve Nut
1	Snap Ring

TOOLS NEEDED
Open End Wrenches
Oil Filter Wrench

PART #	THREAD SIZE
35703	3/4"-16
35704	18mm x 1.5
35706	20mm x 1.5
35724	22mm x 1.5

The purpose of a Spin-on Adapter is to provide external oil lines for remote filter mounts and oil coolers.

INSTALLATION

1. Remove the factory oil filter and clean the oil filter landing surface on the engine block.
2. Take the Hex Sleeve Nut and slide it into the Spin-on Adapters hex feature. Sleeve Nut will only install correctly in one direction. (See Diagram #1)
3. Take the supplied Snap Ring and carefully install into the snap ring groove of the casting making sure it is securely fastened. (See Diagram #1)
4. Apply a light coat of oil onto the O-ring.
5. Take the O-ring and install into the groove on the Spin-On Adapter.
6. Install onto the engine. (See Diagram #2)
7. Hand Tighten with the same force used in tightening a factory oil filter.

Warning: When routing hoses, be sure to keep all hoses away from sharp edges, moving parts and hot engine components. Hoses should be routed carefully and should not be bent in less than a 5" radius.

Important: A kinked hose will restrict flow and could cause engine failure.

VEHICLE TESTING

1. Start the engine and quickly check all connections for leaks.
2. Turn-off the engine and check the oil.
3. Add oil as needed.

Diagram #1

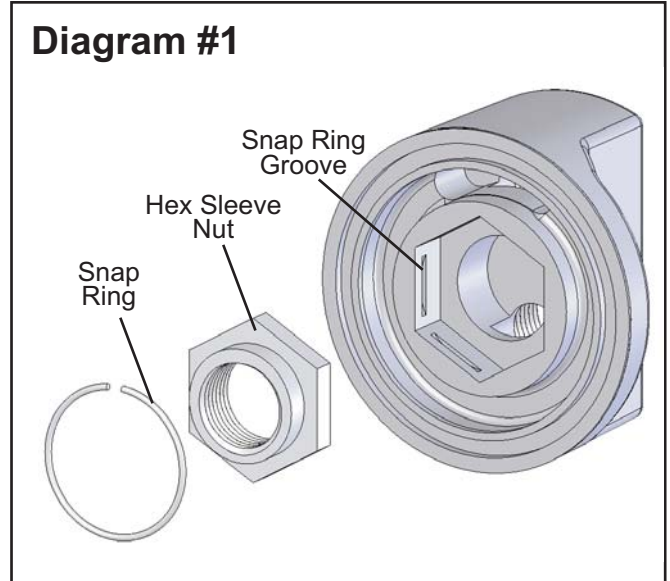
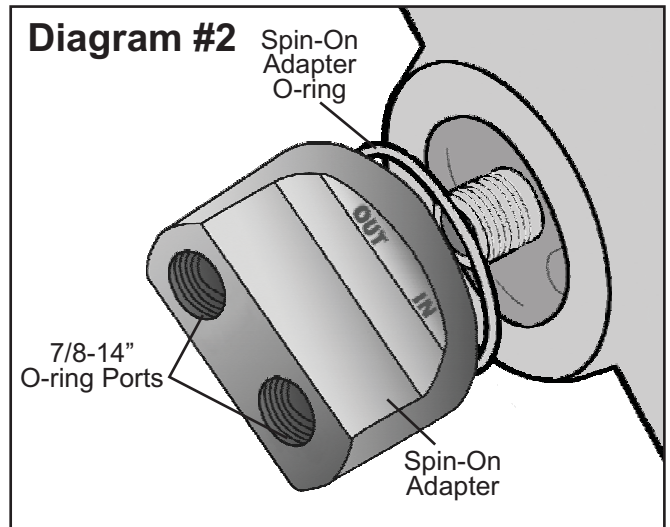

Diagram #2



Warning: Installation of accessories should only be undertaken by those with mechanical knowledge and are familiar with working on vehicles. Always use eye protection (goggles, safety glasses or shield). Park the vehicle in a well lit area, on level ground and apply the parking brake. Only work on a cold vehicle that has been sitting overnight, failure to do so will result in severe burns and injury. Before starting the vehicle, make sure no tools or any other items are left under hood that could interfere with or be drawn into moving parts of the engine. Failure to follow instructions can lead to severe damage and personal injury.